









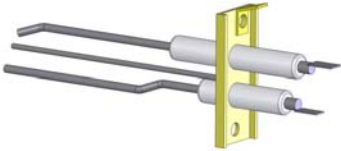

Spare Parts List

The following is a condensed list of spare parts for most ovens. Although it is not necessary to carry any or all spare parts, we do recommend that some of the parts mentioned below be kept as they are crucial to the ovens operation.

Gas System Parts			
Image	Item Description	Brand / Type	Part No.
	Digital Temperature Controller (<i>Single</i>)	RKC. RexCB100	SPAREPT-1008
	Digital Temperature Controller (<i>Double</i>)	RKC. RexCB100	SPAREPT-1009
	Tri-Electrode (<i>Tube Burner</i>)	Tri-Electrode	PARTGAS-1624
	Tri-Electrode (<i>Display Burner</i>) (<i>New design from March 2010</i>)	Tri-Electrode	PARTGAS-1623
	Flame (<i>Ignition</i>) Pack	Brahma 12U	SPAREPT-1010
	Gas Combination Valve	Sit Nova 826	SPAREPT-1011
	Thermocouple	Type K Shielded	SPAREPT-1003

Spare Parts (cont')

Gas System Parts (cont')			
Image	Item Description	Brand / Type	Part No.
	Tube Burner (Complete)	Inspirator	PARTGAS-1617
	Manual Isolation Valve	Generic	PARTCOM-1600
	Tri-Electrode leads (Blue)	1.6m 2.2m	SPAREPT-1004 (1.6m) SPAREPT-1005 (2.2m)
	Relay	Omron LY-2	SPAREPT-1006

Data plate



NOTE: When ordering parts please specify the oven **model and serial number** which is located on the data plate on the inside of the gas control cabinet door.



The following 2 pages identify the single and double gas control systems with some additional part locations and part numbers.

DOOR FEATURES:

"OFF-CONTROL-ON"
3-WAY MAIN SWITCH.
(2.02.012)

BURNER "ON" LAMP. (x1)
(2.02.003)

FAULT-RESET LAMP-BUTTON. (x1)
(2.02.008)

DIGITAL TEMPERATURE CONTROLLER.
RKC-Rex CB100 (SPAREPT-1008)



INSIDE FEATURES:

Double solenoid valve. (x1)
SIT NOVA (SPAREPT-1011)
(gas pressure regulator built in.)

Spark/flame management pack. (X1)
BRAHMA; CM12U .(SPAREPT-1010)

High tension igniter leads.
Sets of 3 leads. (Order
by required length.)

Manual isolation valve.(x1)

Thermocouple. (k-type)(SPAREPT-1003)
(Terminates in the floor of the oven)

Terminal Block

Circuit Breaker

Relay (SPAREPT-1006)



DOOR FEATURES:

"OFF-CONTROL-ON"
3-WAY MAIN SWITCH.
(2.02.012)

BURNER "ON" LAMP. (x2)
(2.02.003)

FAULT-RESET LAMP-BUTTON. (x2)
(2.02.008)

DIGITAL TEMPERATURE CONTROLLER.
RKC-Rex CB100 (SPAREPT-1009)



INSIDE FEATURES:

Double solenoid valve. (x2)
SIT NOVA (SPAREPT-1011)
(gas pressure regulator built in.)

Spark/flame management pack. (X2)
BRAHMA; CM12U .(SPAREPT-1010)

High tension igniter leads.
Sets of 3 leads. (Order
by required length.)

Manual isolation valve.(x2)

Thermocouple. (k-type)
(SPAREPT-1003)
(Terminates in the floor of
the oven)







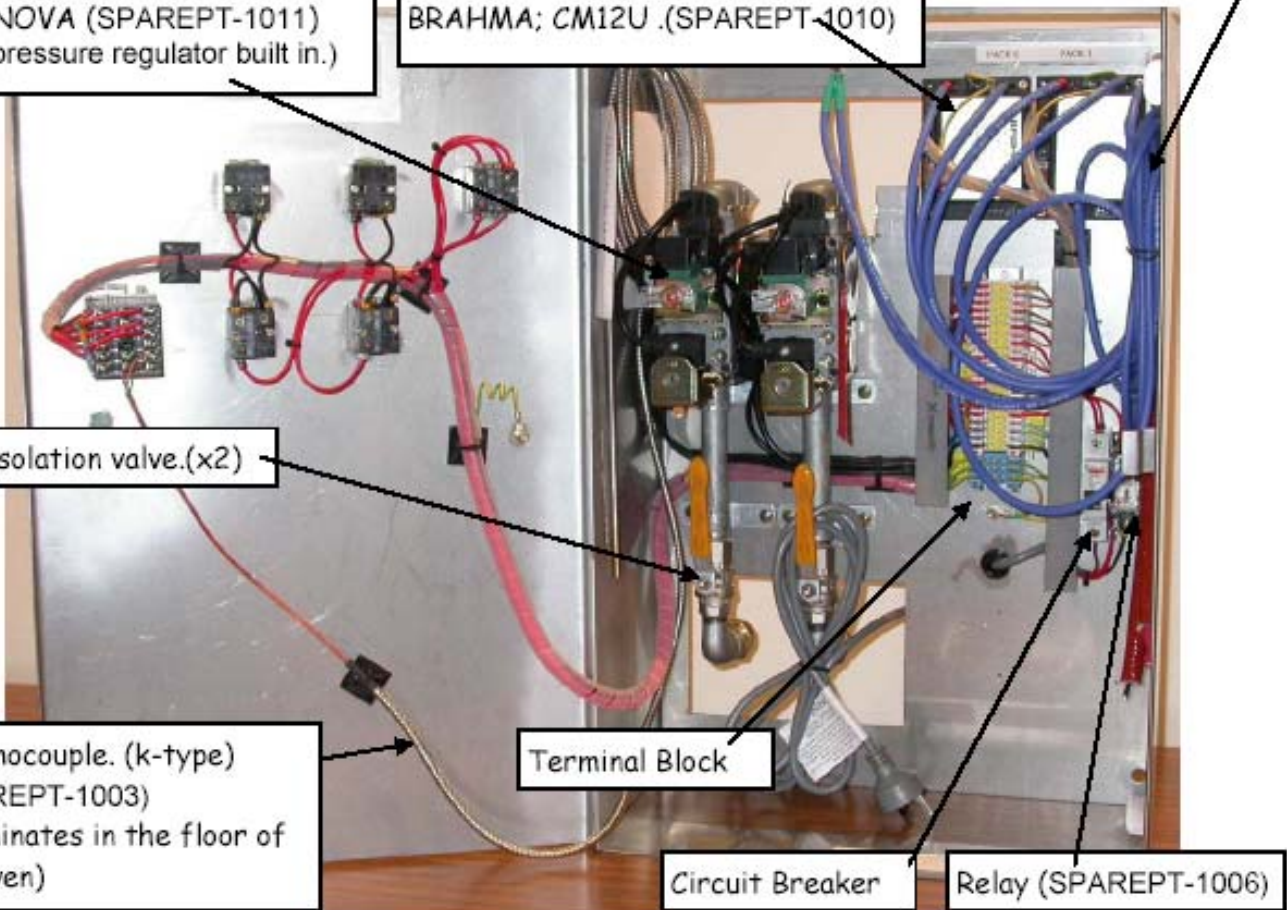

Terminal Block

Circuit Breaker





Relay (SPAREPT-1006)



Spare Parts (cont')

Char Grill Parts			
Image	Item Description	Brand / Type	Part No.
	Char Grill Bed Long <i>(Standard 600mm for models prior to July 2010)</i>	Stainless Steel 150mm wide	AGRILL-1100
	Char Grill Bed Short <i>(500mm models prior to July 2010)</i>	Stainless Steel 150mm wide	AGRILLS-1100
	Char Grill Plate Standard <i>(Models after July 2010)</i>	Stainless Steel 200mmwide	SPAREPT-1050
	3 Way Winged Pilot <i>(Includes pilot jet)</i> <i>(Models after 2010 with spark electrodes with lead)</i>	Robert Shaw	SPAREPT-1015
	Char Grill Thermocouple <i>(900mm)</i>	Robert Shaw	SPAREPT-1014
	Char Grill Pilot spark electrode – with lead and protective sheath	Robert Shaw	SPAREPT-1049
	SS Pilot Tube <i>(1200mm)</i>	Generic	SPAREPT-1017
	SS Pilot Tube <i>(900mm)</i>	Generic	SPAREPT-1016
	Char Grill Piezo Igniter	Generic	SPAREPT-1051

Spare Parts (cont')

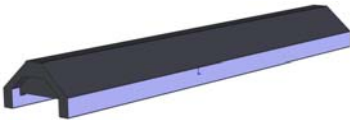
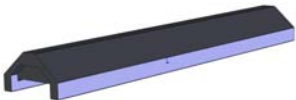
Char Grill Parts (cont')			
Image	Item Description	Brand / Type	Part No.
	Char Grill Gas Control Valve Knob (Control Knob ONLY)	PEL	SPAREPT-1013
	Char Grill Gas Control Valve (With Control Knob)	PEL	SPAREPT-1012
	Ribbon Burner AC19	Carmichael	SPAREPT-1018
	Ribbon Burner AC14	Carmichael	SPAREPT-1019
	Cast Iron Radiant (480mm)	Carmichael	SPAREPT-1020
	Cast Iron Radiant (350mm)	Carmichael	SPAREPT-1020

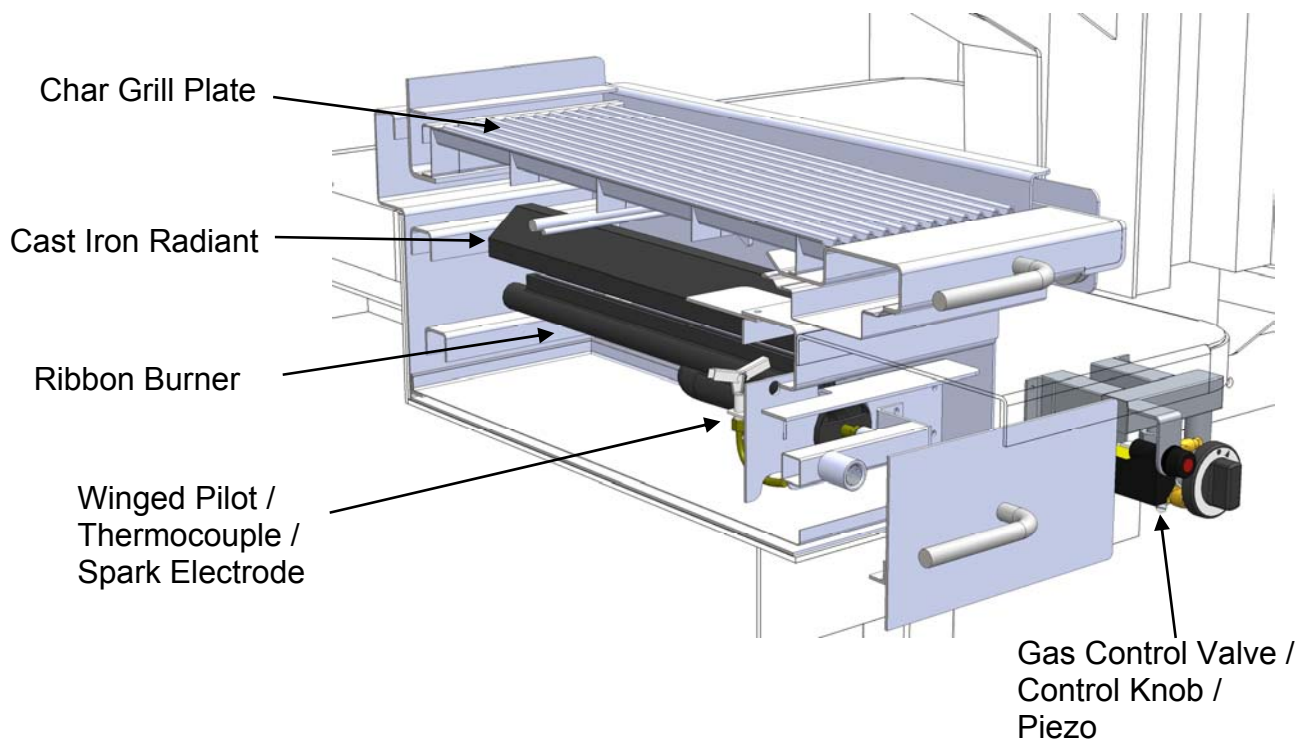

Spare Parts (cont')

General Oven Parts			
Image	Item Description	Brand / Type	Part No.
	Spotlight Globe	Ultralife 12V 50W	ASPOTLT-1603
	Spotlight Glass <i>(with edge Gasket)</i>	Tempered Glass	ASPOTLT-1602
	Viewing Window Inner Glass <i>(with edge Gasket)</i>	Robax	AVWSTND-1607
	Peel Aluminium <i>(With 1300mm wooden Handle)</i>	Aluminium	AACTOOL-1602
	Rake	Stainless Steel	AACTOOL-1600
	Brass Brush	Brass Bristols	AACTOOL-1603
	Shovel	Stainless Steel	AACTOOL-1601
	Grill Spigot Brush	Nylon	AACTOOL-1604

Spare Parts (cont')

Spray Filter Parts			
Image	Item Description	Brand / Type	Part No.
	Spray Filter Solenoid Valve	SMC VXZ2240	ASFSTND-1611
	Spray Filter Spray Nozzle (32L/Hr) (Models prior to July 2010)	1/4" B SS 1 BSPT	ASFSTND-1613
	Spray Filter Spray Nozzle (11.2l/Hr) (2 per Spray Filter) (Models after July 2010)	B1/8 TT-SS + T4W-SS	ASFSTND-1606
	Spray Filter 1/2" Y-Strainer <i>(In line Filter)</i>	CW617N PN20	ASFSTND-1612
	Spray Filter Manual Isolation Valve	15mm Ball Valve	PARTCOM-1600

